

Chemical Oceanography

Organic Matter Cycling

Dr. David K. Ryan

Department of Chemistry

University of Massachusetts Lowell

&

Intercampus Graduate School

of Marine Sciences and Technology

http://faculty.uml.edu/david_ryan/84.653

Organic Compounds in the Sea

- # Where do they come from?
- # What are they?
- # Why are they important?
- # Where do they go?

Read: Emerson & Hedges Chapters 8 & 11

Libes Chapters 22 & 23 (posted on website)

Organic compounds produced during Primary Production

- # Phytoplankton fix CO_2 to make “soft parts” (organic) (Broecker & Peng, Chapter 1)
- # Consumed by other organisms to make their soft tissue
- # All organisms exude and excrete soluble organic compounds
- # Particulate organics arise from dead organisms (detritus) and fecal material from live organisms

Libes

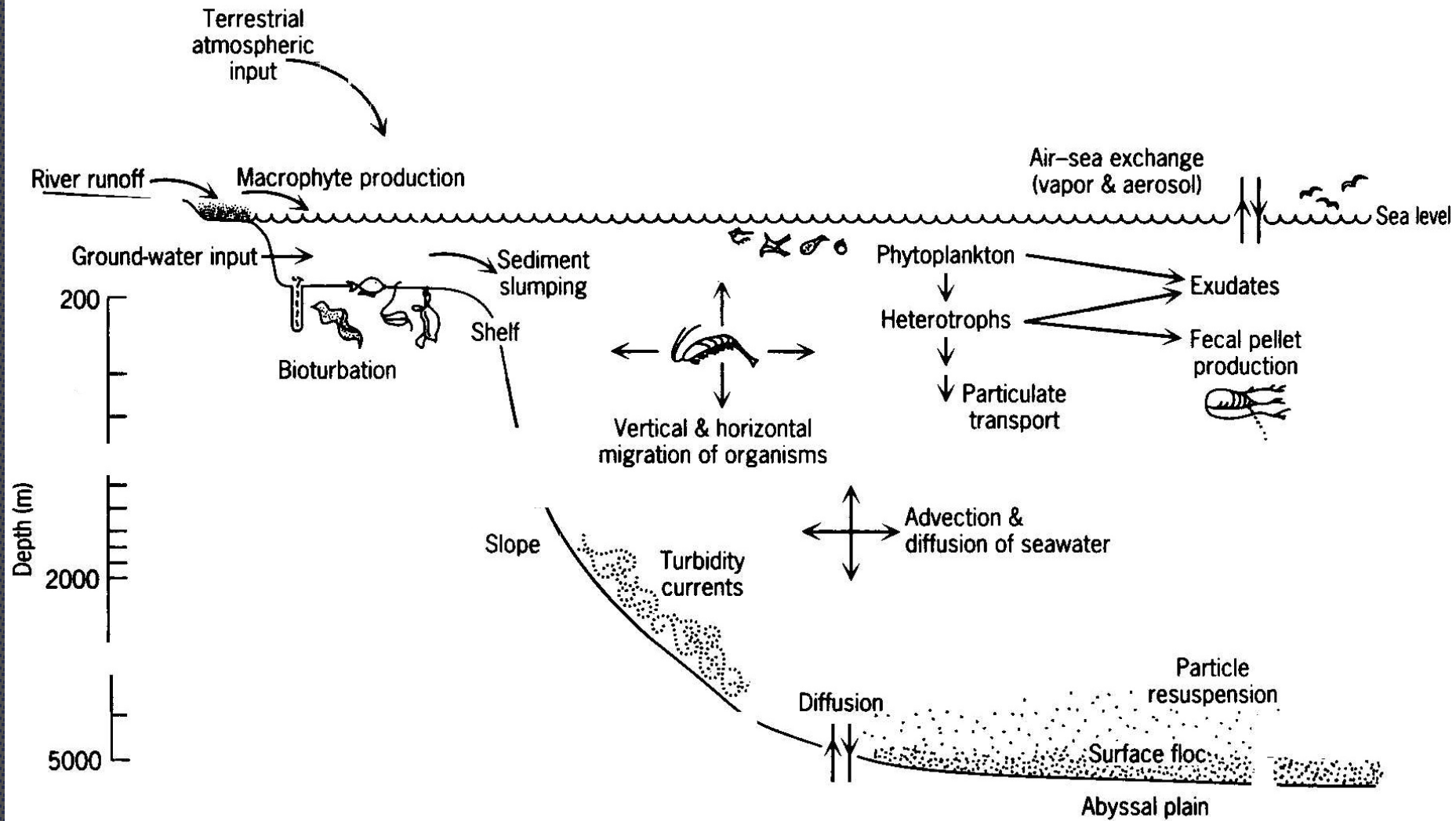
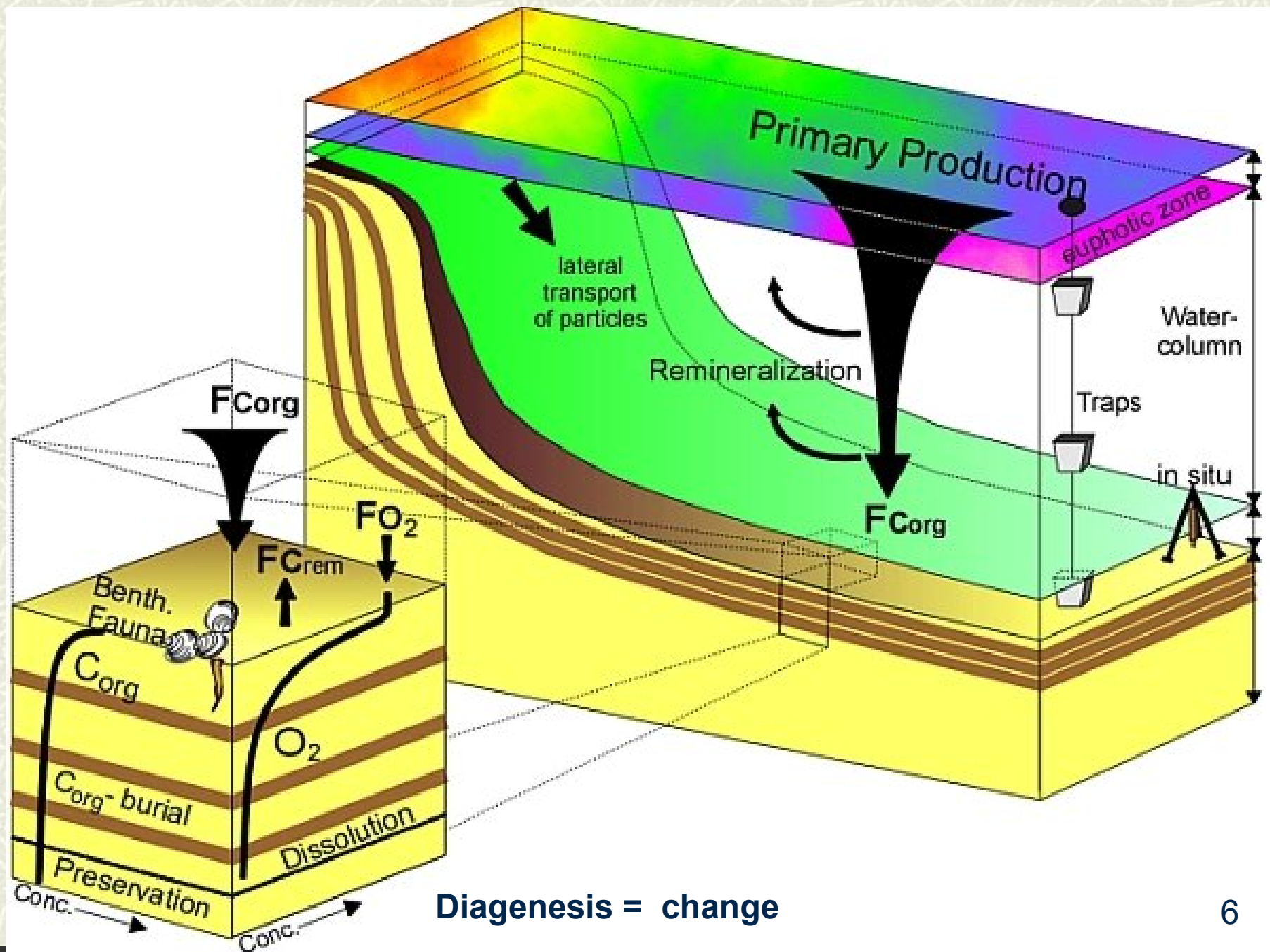

Fig 22.1 Factors influencing OM distribution

Primary Production continued

- # Organic particles sink under the influence of gravity
- # Become degraded by bacteria as they sink
- # Consequently, the destruction of organic matter occurs at greater depth than formation
- # Destroyed organics are remineralized to inorganic species (e.g., CO_3^{2-} & NO_3^-)
- # Deep ocean becomes enriched in nutrients



Diagenesis = change

Broecker & Peng Figure 1.1

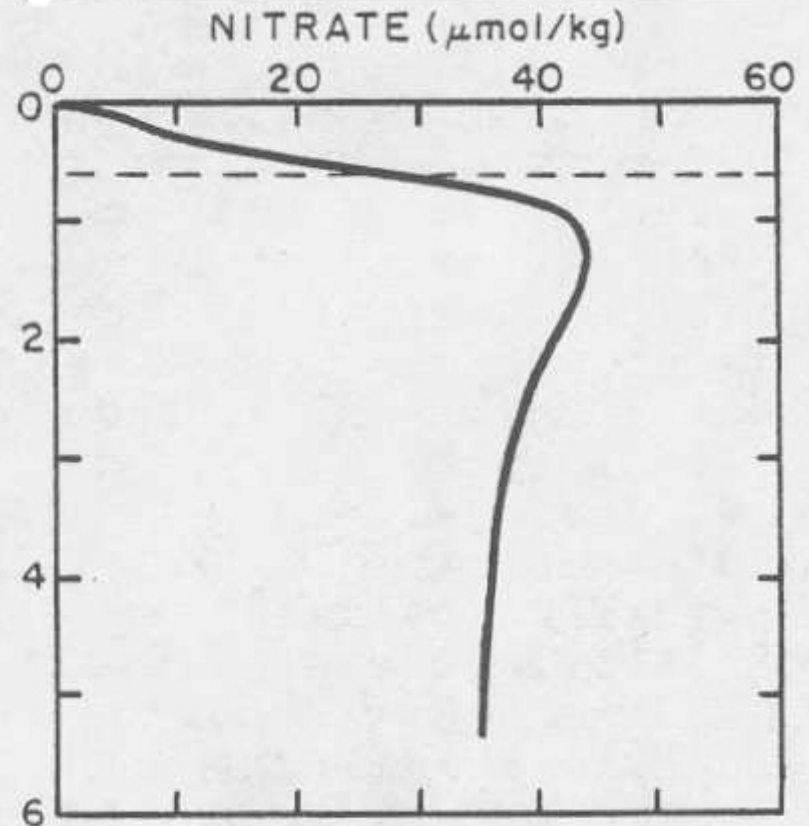
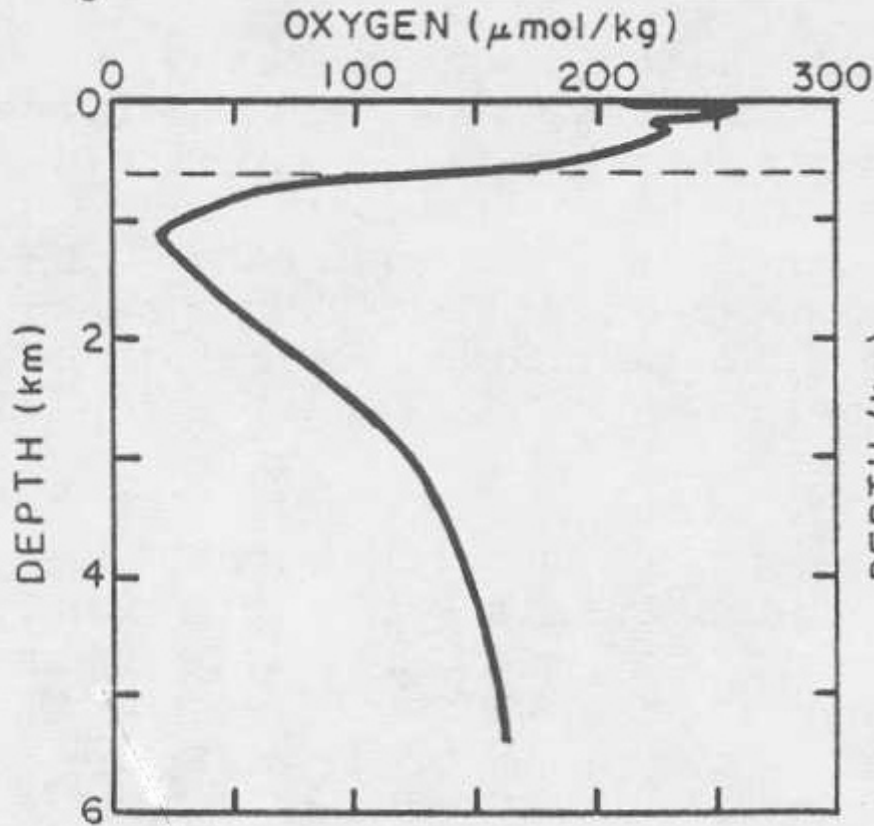

Primary Production continued

- # Large particles are more likely to make it all the way to the sediments and be buried
- # Greater than 99% of organic matter is remineralized, very little reaches sediments
- # Is there a consequence of the above info for large scale iron fertilization of the oceans?

Primary Production continued

- # Large particles are more likely to make it all the way to the sediments and be buried
- # Greater than 99% of organic matter is remineralized, very little reaches sediments
- # Is there a consequence of the above info for large scale iron fertilization of the oceans?

Yes, stimulating primary production at the surface results in an increased production of particulate organic material that is remineralized at greater depths and stores carbon in the deep ocean.

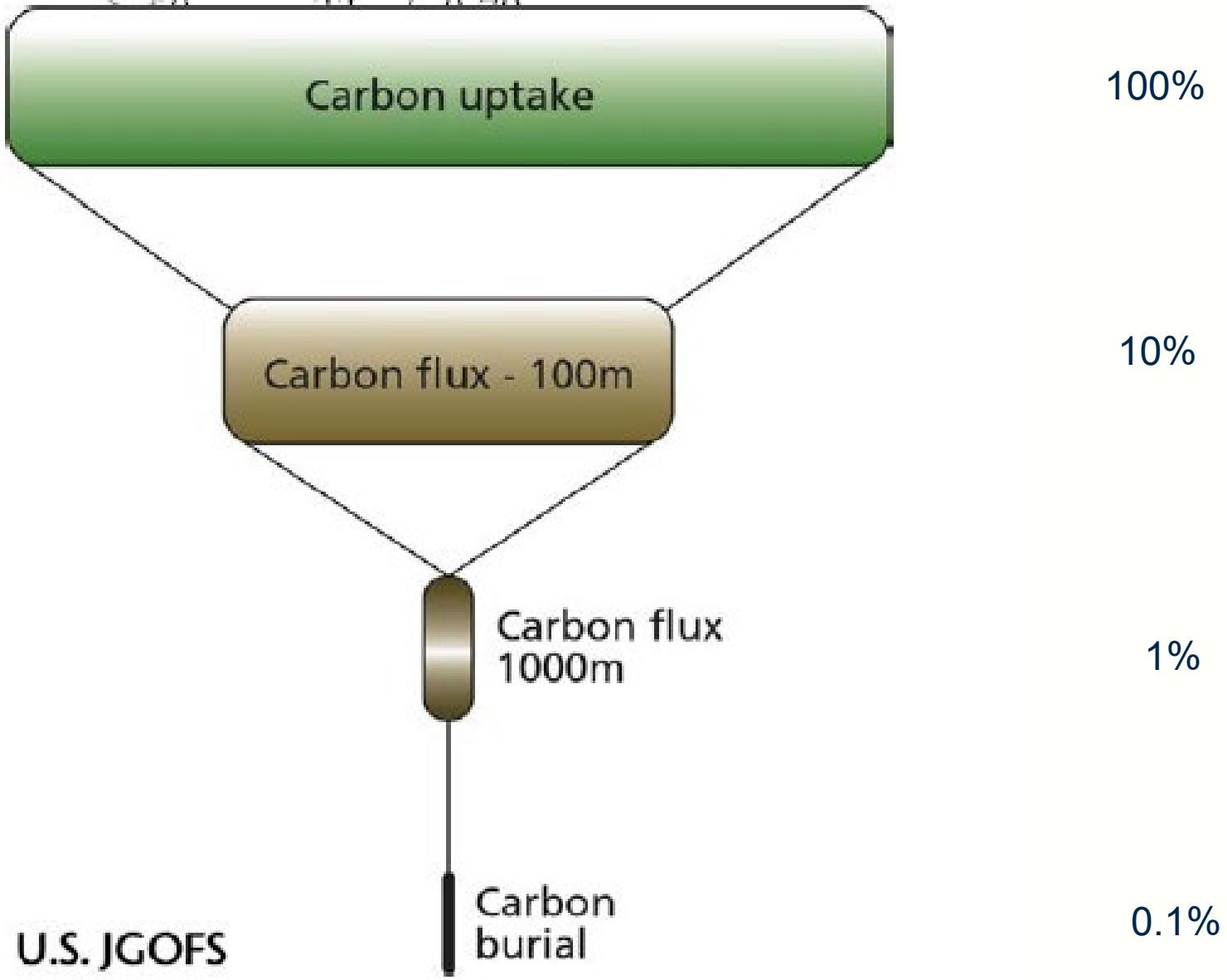

Marine Snow



Marine Snow

Verdugo et al., 2004 “The oceanic gel phase:
a bridge in the DOM–POM continuum”
Marine Chemistry 92, 67-85.

Handout posted on website, Course Materials

Nomenclature & Units for Carbon

- # Organic compounds are carbon containing (except oxides, carbonate minerals, elemental)
- # The symbol for carbon is C
- # Organic materials in the ocean are sometimes discussed as a whole, including all compounds regardless of structure
- # Specifying concentrations is best done in grams or moles of carbon (C) per L or kg of seawater
 $\mu\text{M C}$ or mg C/L or mg C/kg

TABLE 9.7
Levels of Dissolved and Particulate
Organic Material in Natural Waters

Source	Dissolved	Particulate
Seawater		
Surface	75–150 μM	1–17 μM
Deep	4–75	0.2–1.3
Coastal	60–210	4–83
Estuarine	8–833	8–833
Drinking water	17	
Ground water	58	
Precipitation	92	
Oligotrophic lake	183	80
River	420	170
Eutrophic lake	830–4,170	170
Marsh	1,250	170
Bog	2,500	250

Concentrations of organic material expressed in μM = micromoles of C per liter of solution

Millero, 1996
 Table 9.8 in
 Millero, 2007

Nomenclature & Units for Carbon

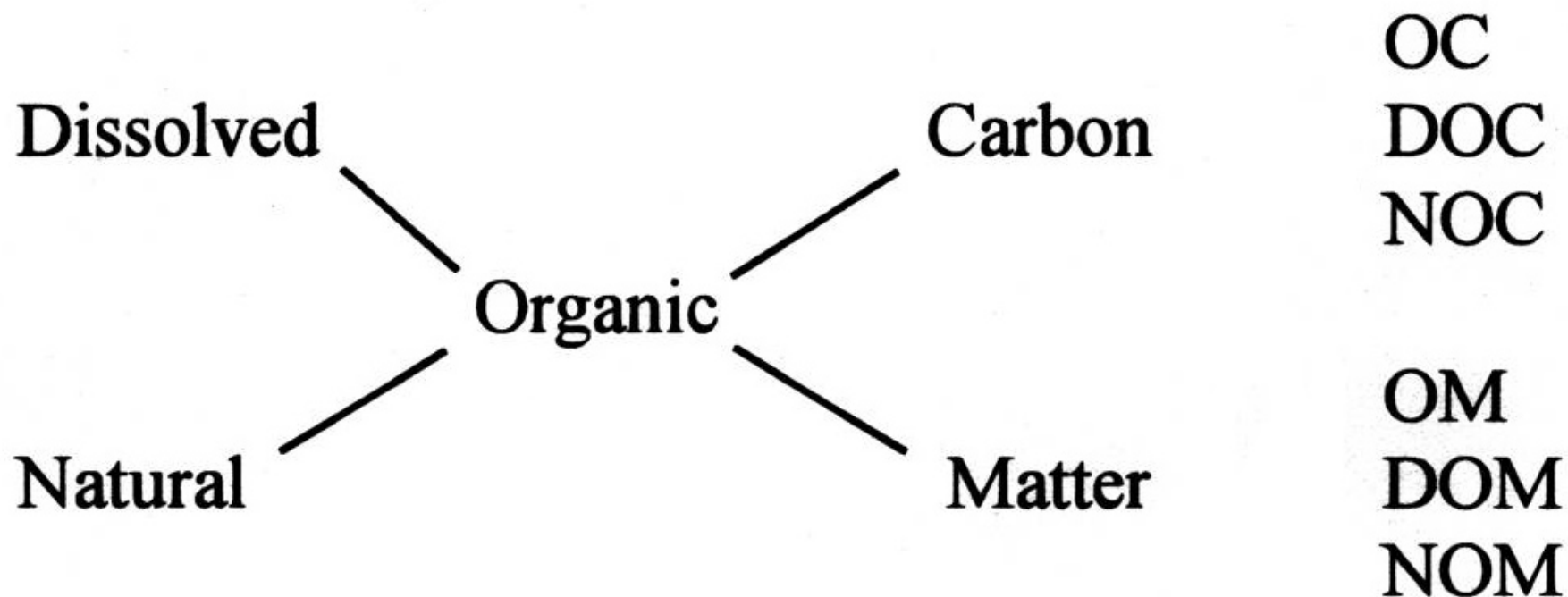

DOC is most common abbreviation – specifies **C**
DOM or NOM concentrations may differ from
DOC by a factor of 2 to account for % C (Ryan 2013)

TABLE 22.1

**Operationally Defined Fractions of
Organic Matter^a**

Operational Fraction

Particulate organic matter	POM
Dissolved organic matter	DOM
Particulate organic carbon	POC
Dissolved organic carbon	DOC
Dissolved inorganic carbon	DIC
Particulate organic nitrogen	PON
Dissolved organic nitrogen	DON
Dissolved inorganic nitrogen	DIN

^aAlso included are some inorganic fractions.

Libes,
1992

Relatively New Nomenclature

CDOM is colored or chromophoric DOM

Term used to distinguish light absorbing material from OM that has no light absorption or color

Typically measured spectrophotometrically by:

- UV/vis absorption measurements
- Fluorescence spectrometry

Humic Materials or Humic Substances

- # Complex organic molecules of natural origin
- # Much is known about properties/importance
- # Some is known about structural components
- # Little is known about exact chemical nature or exact structure – because:
 - Complexity
 - Heterogeneity
 - Concentrations
 - Deficiencies in analytical techniques
 - Interfering species

Organic Compounds in the Sea

Where do they come from?

What are they?

- Hydrocarbons
- Carbohydrates (polysaccharides), sugars
- Lipids, fats, waxes, oils, fatty acids
- Pigments
- Nucleic acids, RNA, DNA
- Amino acids, polypeptides, proteins, enzymes
- Low molecular weight carboxylic acids
- Humic Substances

Organic Compounds in the Sea

Where do they come from?

- Primary Production
- Riverine and Terrestrial Runoff

To a much lesser extent

- Atmospheric Deposition
- Sediment Diffusion & Resuspension
- Groundwater input
- Vents, etc.

Average Concentrations of Organic Compounds in Baltic and North Sea Water

Components	Concentration ($\mu\text{g C liter}^{-1}$)
Free amino acids	10
Combined amino acids	50 (to 100?)
Free sugars	20
Combined sugars	200
Fatty acids	10
Phenols	2
Sterols	0.2
Vitamins	0.006
Ketones	10
Aldehydes	5
Hydrocarbons	5
Urea	10
Uronic acids	18
Approximate identified total	$340 \mu\text{g C liter}^{-1}$
Approximate total	$4000 \mu\text{g C liter}^{-1}$

Morel, 1983

Average Concentrations of Organic Compounds in Baltic and North Sea Water

Components	Concentration ($\mu\text{g C liter}^{-1}$)
Free amino acids	10
Combined amino acids	50 (to 100?)
Free sugars	20
Combined sugars	200
Fatty acids	10
Phenols	2
Sterols	0.2
Vitamins	0.006
Ketones	10
Aldehydes	5
Hydrocarbons	5
Urea	10
Uronic acids	18
Approximate identified total	$340 \mu\text{g C liter}^{-1}$
Approximate total	$4000 \mu\text{g C liter}^{-1}$

What is this stuff?

Morel, 1983

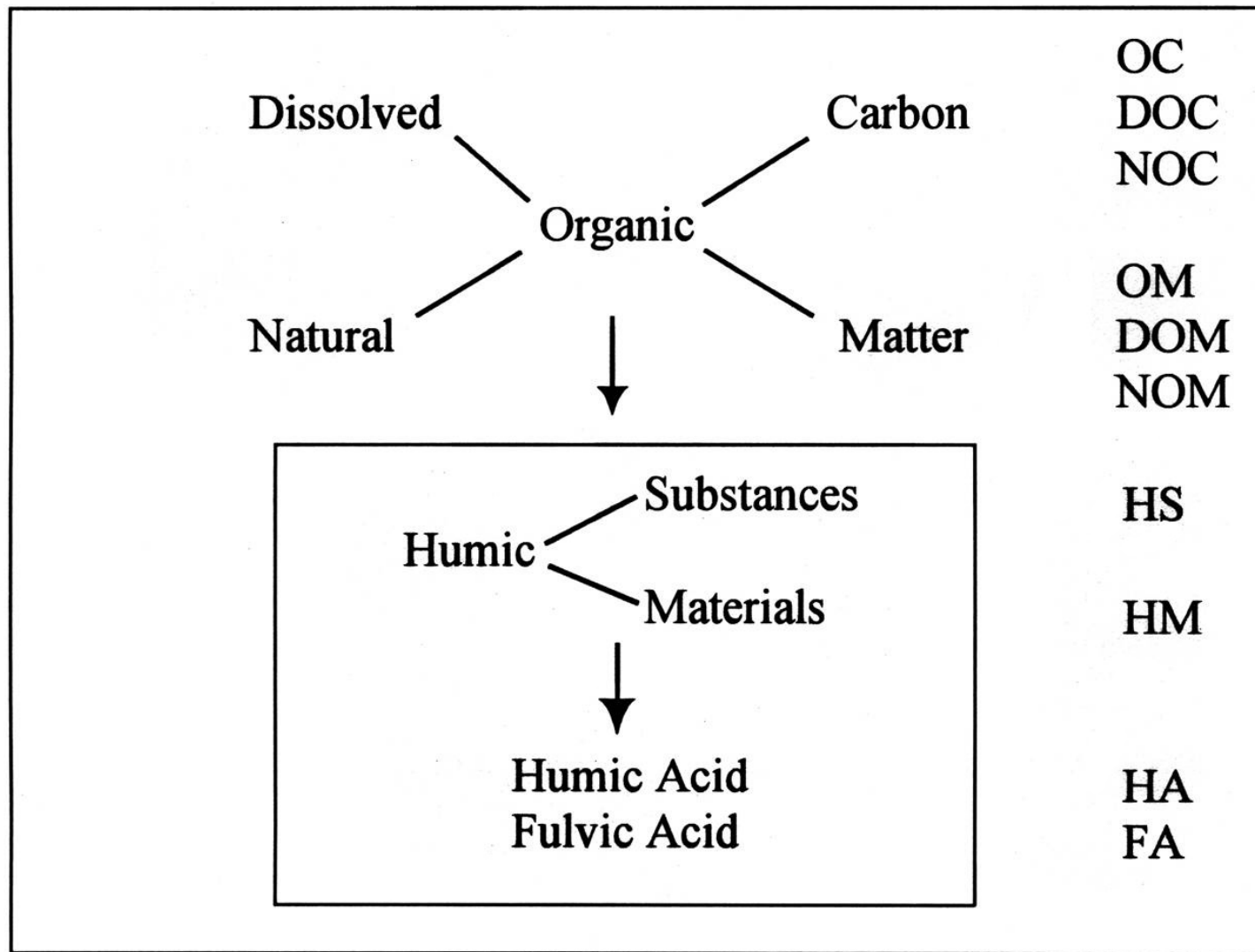

Ryan (2000)

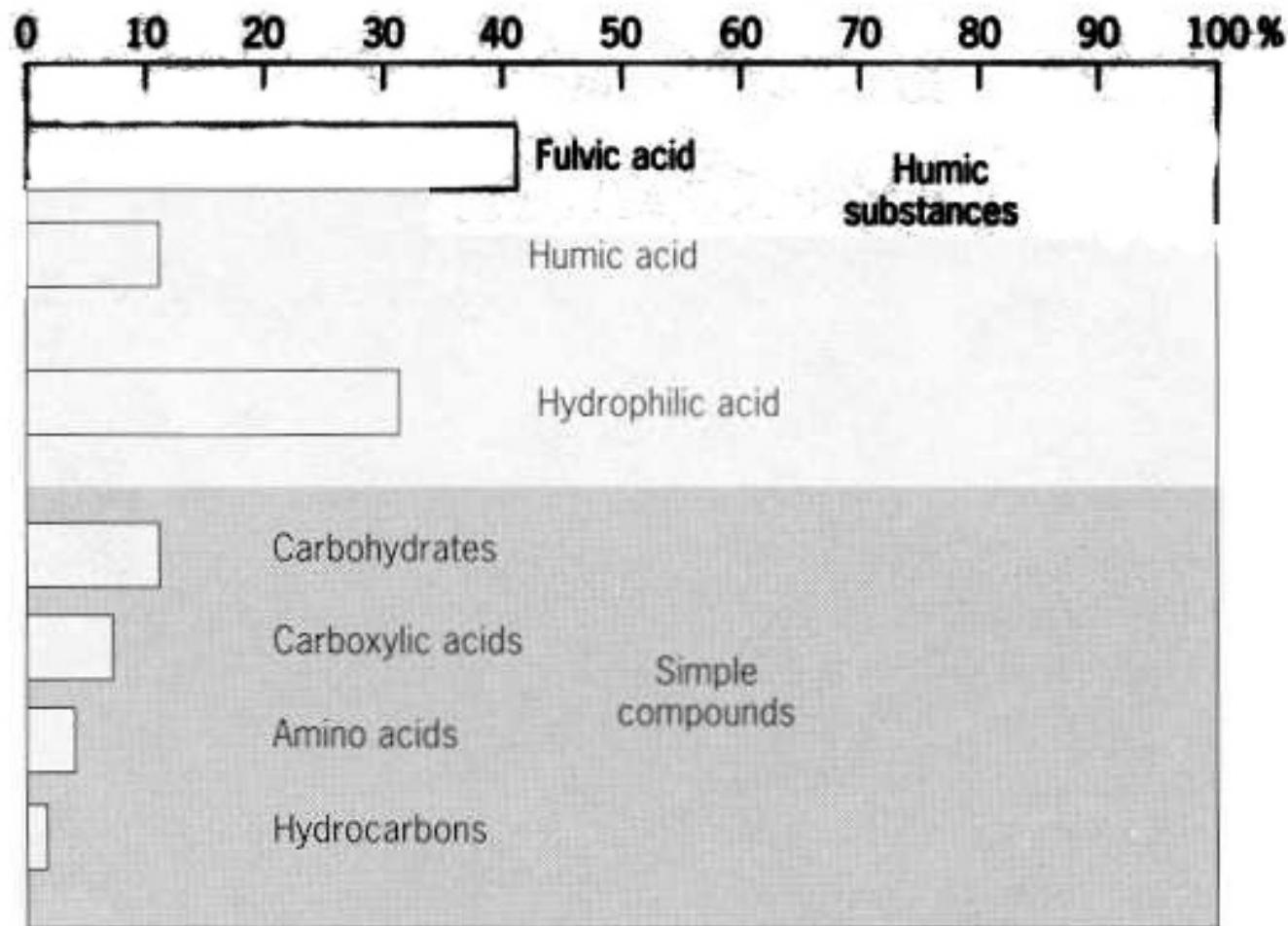

Libes, 1992

FIGURE 23.13. Composition of dissolved organic carbon in average river water with a DOC concentration of 5 mg/L. *Source:* From *Organic Geochemistry of Natural Waters*, E. M. Thurman, copyright © 1985 by Kluwer Academic Publishers, Dordrecht, The Netherlands. Reprinted by permission.

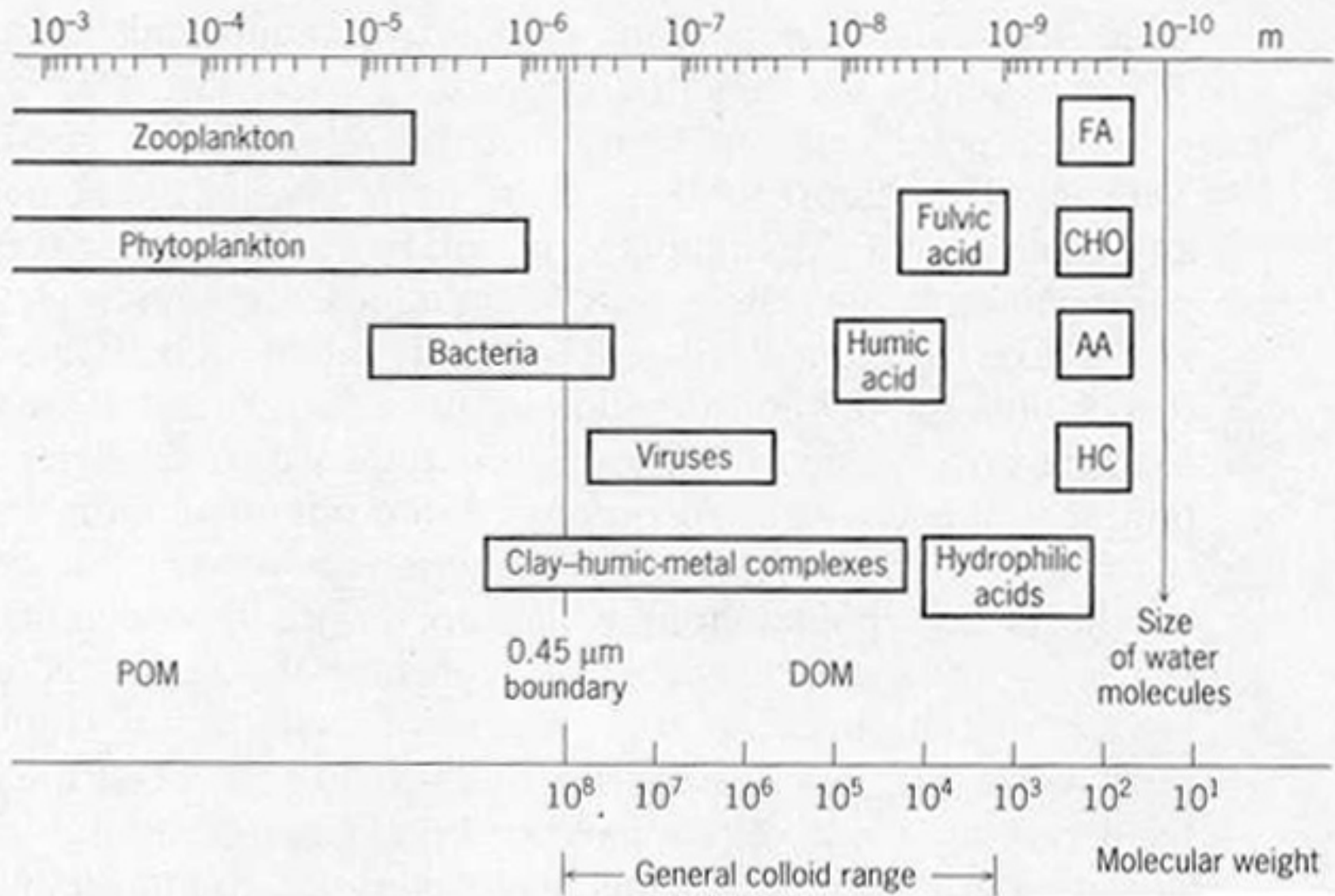

FA Fatty acids
 CHO Carbohydrates
 AA Amino acids
 HC Hydrocarbons

PORE SIZE OF FILTRATION PROCESSES

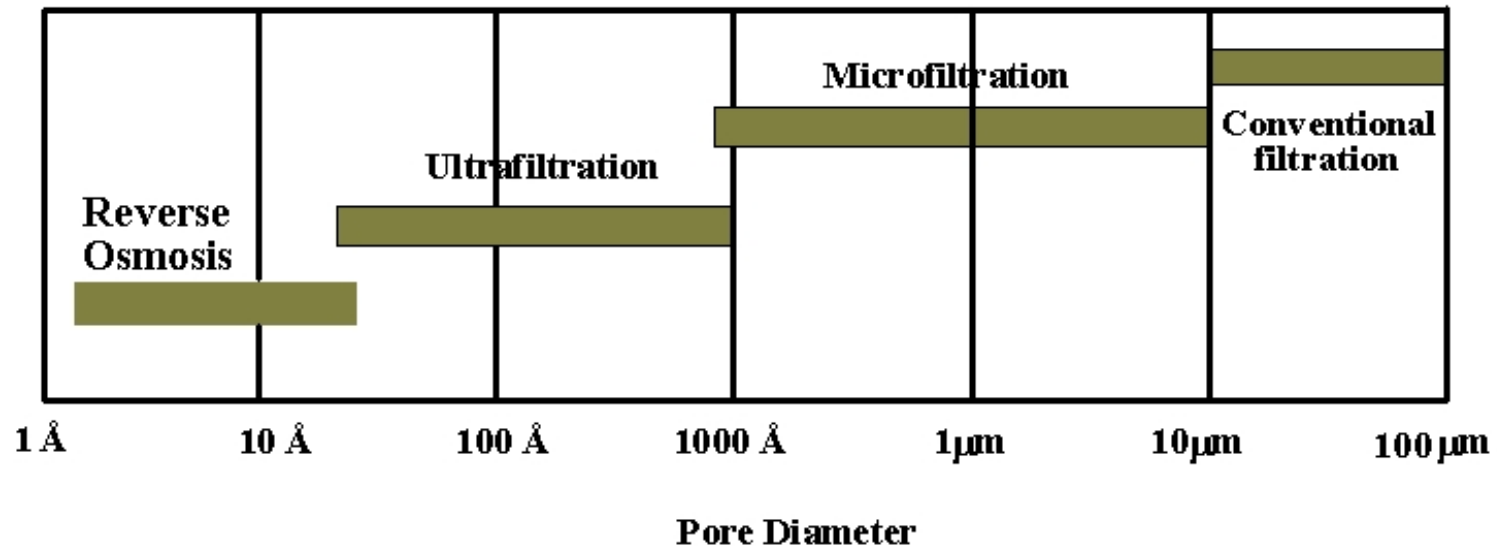
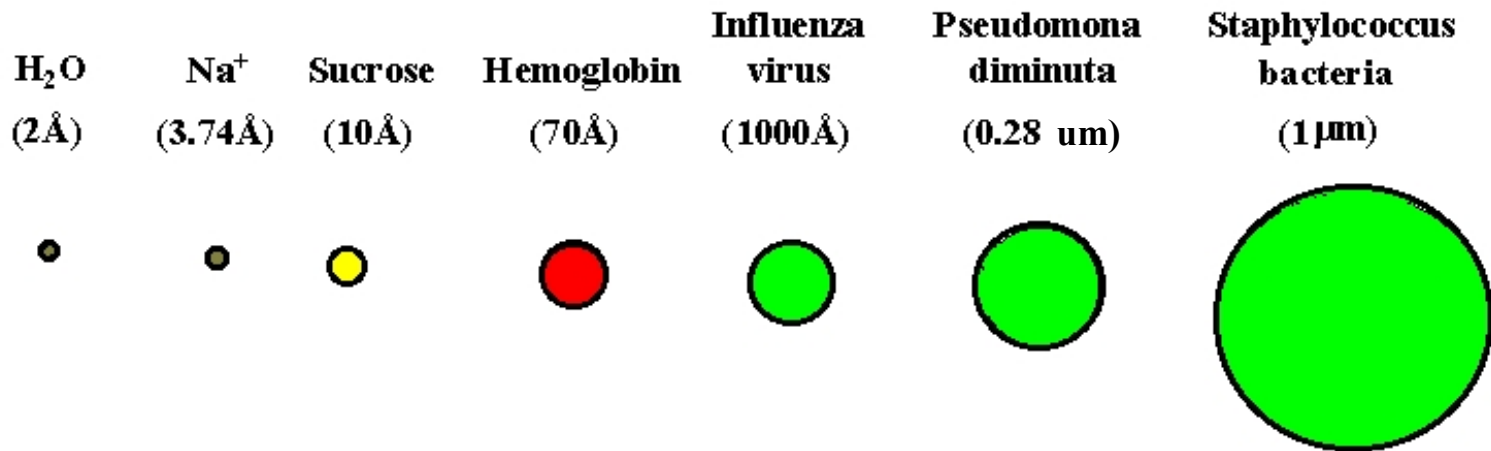

Millero,
1996

Organic Compounds in the Sea

Where do they come from?

- Primary Production
- Riverine and Terrestrial Runoff

To a much lesser extent

- Atmospheric Deposition
- Sediment Diffusion & Resuspension
- Groundwater input
- Vents, etc.

Organic Compounds in the Sea

Where do they come from?

What are they?

Why are they important?

Where do they go?

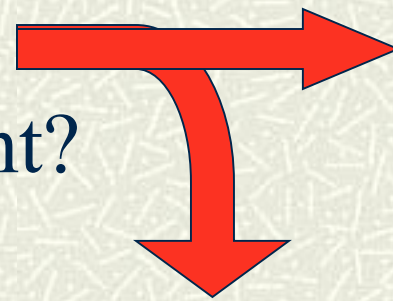

POC

■ Detritus

■ Fecal Mat.

DOC

■ Biological molecules (lipids, proteins, carbohydrates, etc., etc.)

■ Hydrocarbons

■ Humic Materials (=other stuff)

All Dissolved Organic Compounds

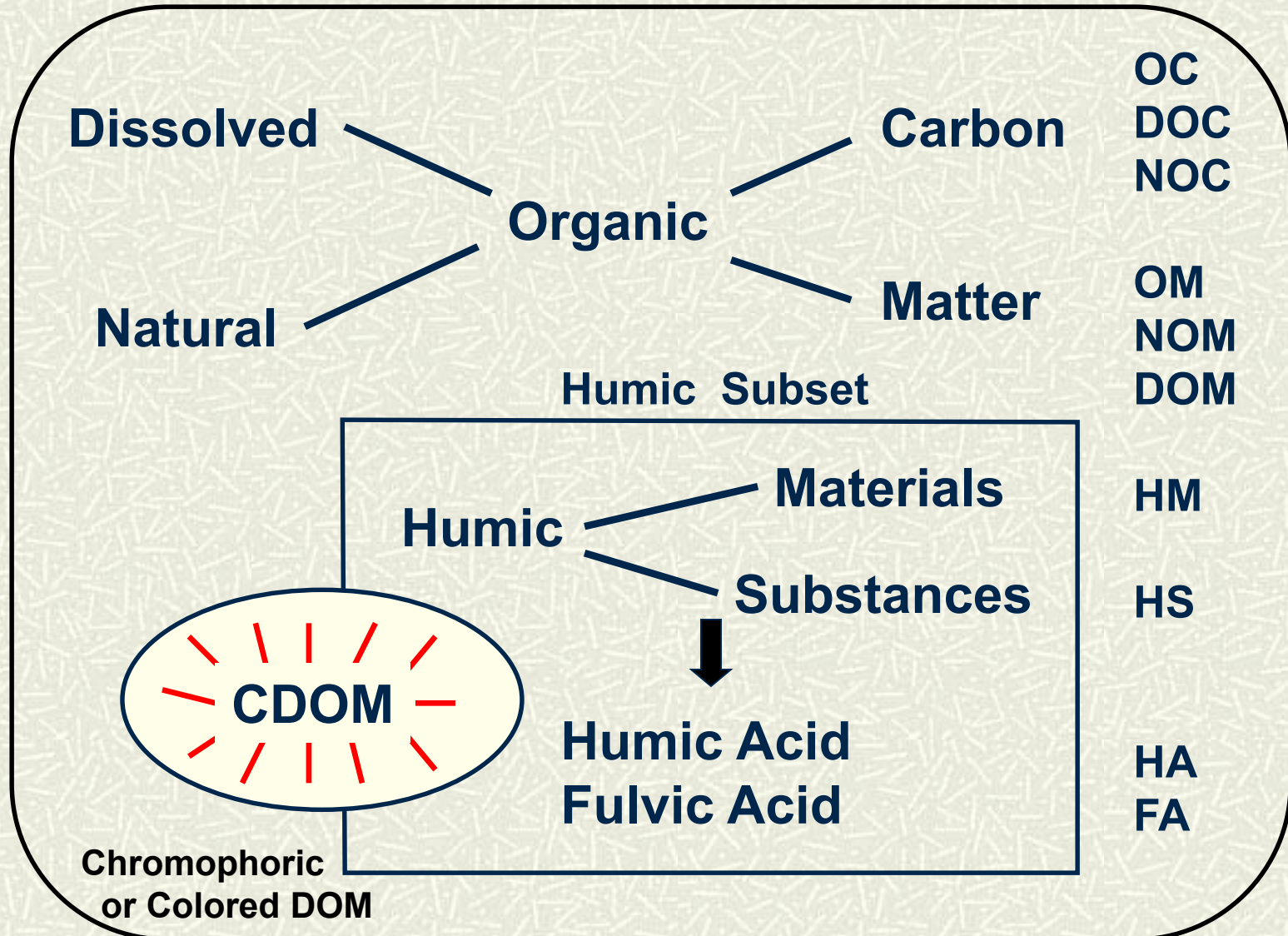

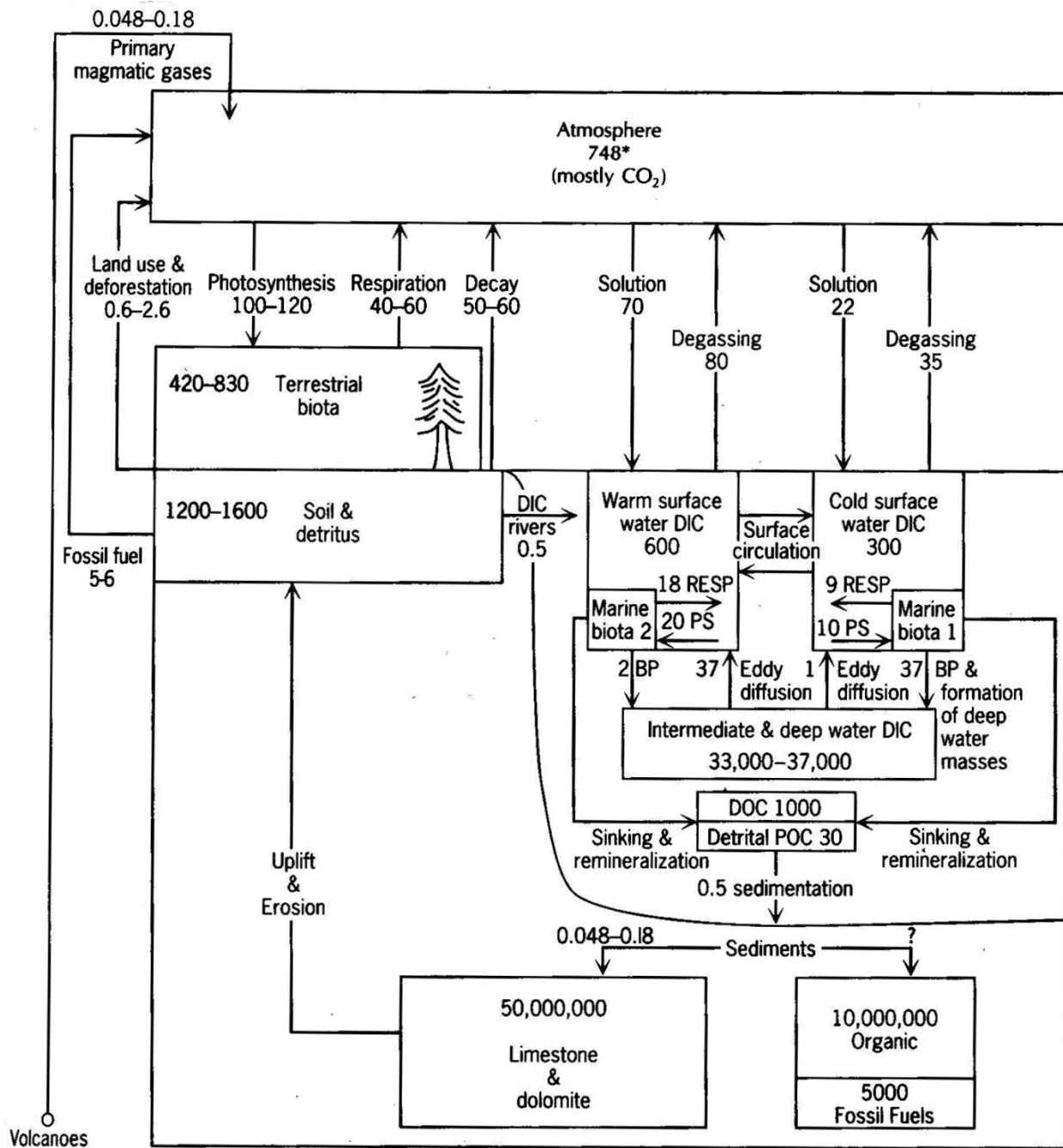

Carbon Cycle Libes, 1992

Inventories in
 10^{15} g C = BMT

Fluxes (arrows)
 10^{15} g C/yr

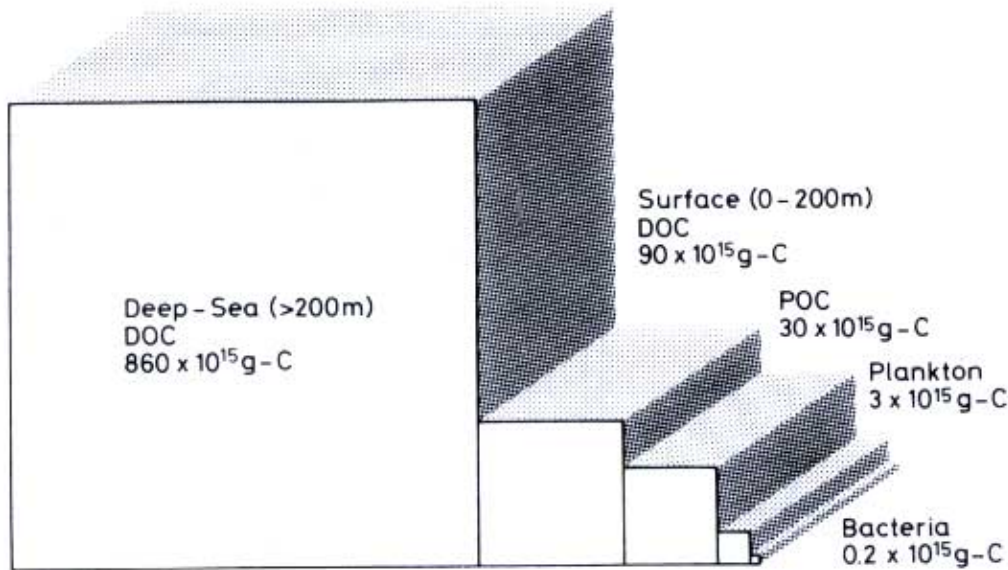

(a)

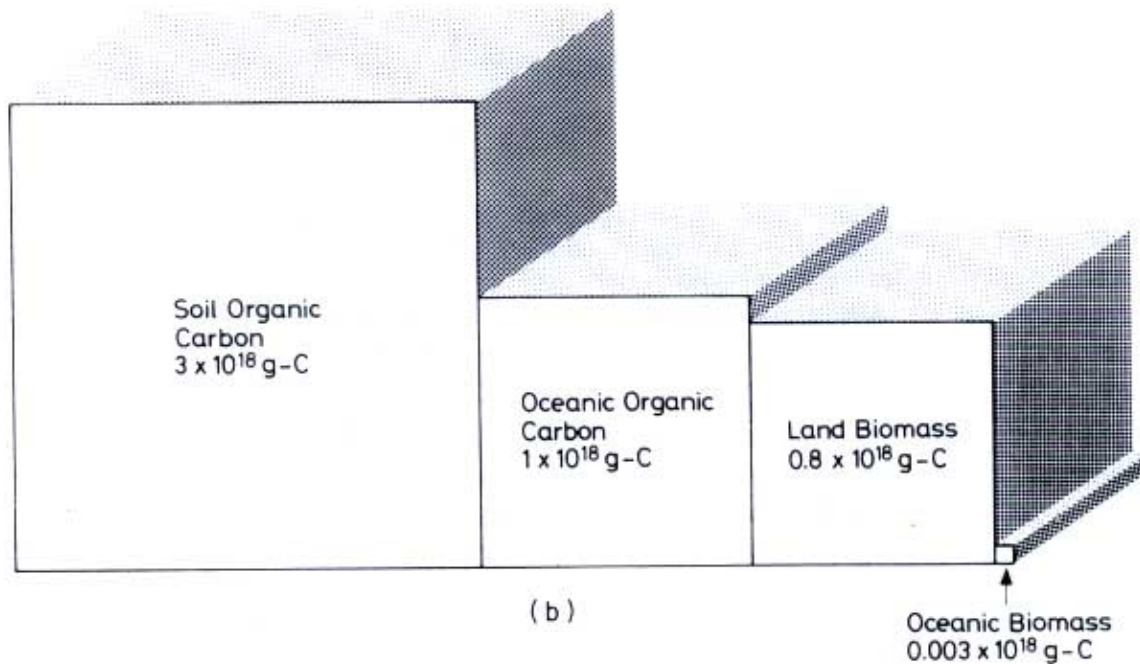

(b)

Distribution of Organic Carbon

(a) Major compartments in the global ocean

(b) Major compartments for the planet

Cauwet, 1978